

JET PUMPS MODELS 506121S (VERSION W 2015)

AND OTHER PRODUCTS
506127S, 506128S
506131S, etc.

Please read these instructions carefully. **Failure** to comply to instructions and **designed** operation of this system, may **void** the warranty.

2190 Dagenais Blvd. West Tel. : 514.337.4415
Laval (Quebec) Fax : 514.337.4029
Canada info@burcam.com
H7L 5X9 see us at www.burcam.com

Your pump has been carefully packaged at the factory to prevent damage during shipping. However, occasional damage may occur due to rough handling. **Carefully inspect your pump** for damages that could cause failures. Report any damage to your carrier or your point of purchase.

PRIMING PROCESS

Follow all these inside step by step instructions to install your pump. Use teflon tape on all threads. (1) Fill the suction line with water and connect it to the suction inlet. (2) Remove the priming plug and fill the pump body with water. (3) Screw the plug to the priming inlet. (4) Turn the power on. The pump should deliver water to the plumbing line within 30 seconds. If not, unplug the pump and repeat the process at step 2.

FACTORY SET VOLTAGE 115 V TO CHANGE THE VOLTAGE :

- Before changing the voltage connection:
- Ensure the power to the pump is disconnected.
 - Open motor junction box cover.
 - Please select the up knob position for 115V or down knob position for 230V.
 - Connect to appropriate voltage.
 - Close motor junction box.

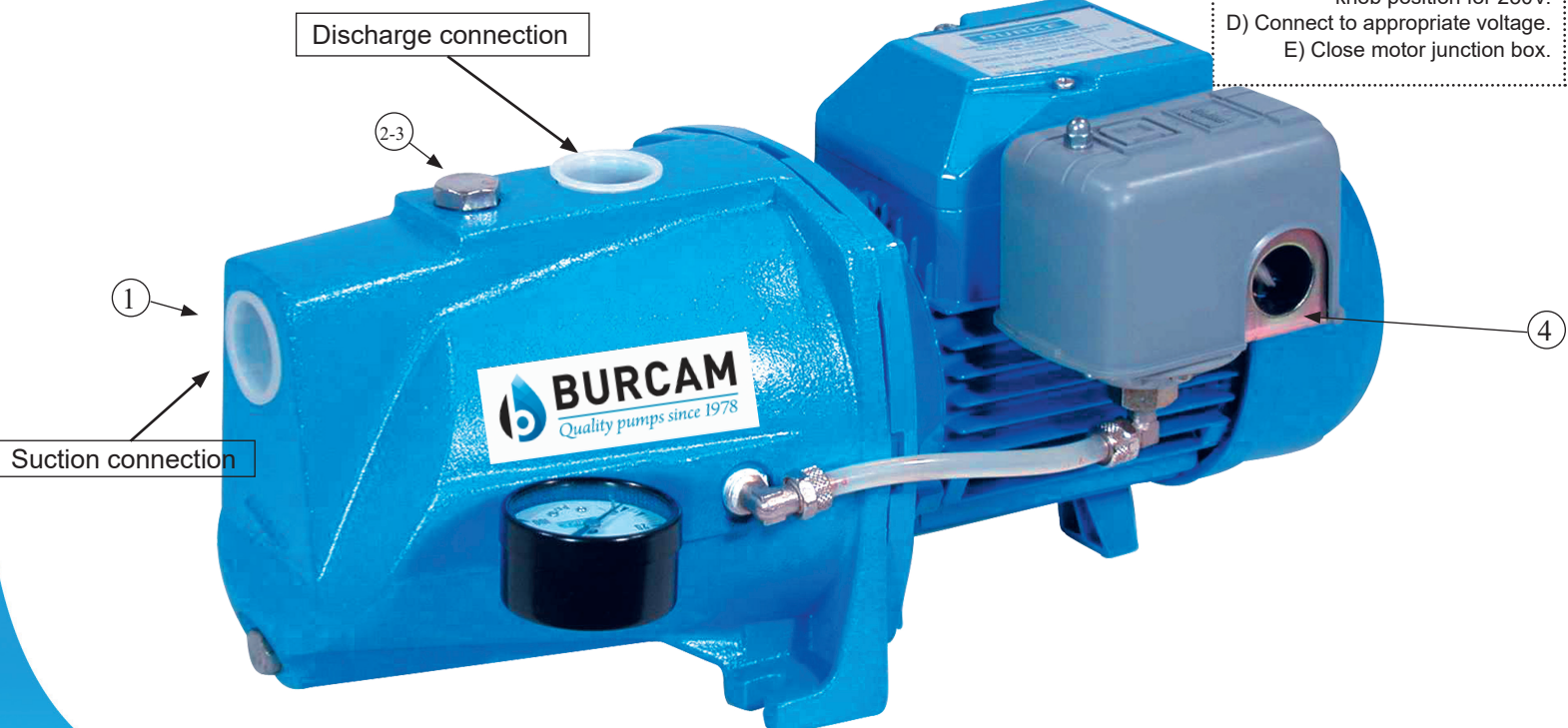

Safety Instructions:

This fine pump that you have just purchased is designed from the latest in material and workmanship. Before installation and operation, we recommend the following procedures:

- A** CHECK WITH YOUR LOCAL ELECTRICAL AND PLUMBING CODES TO ENSURE YOU COMPLY WITH THE REGULATIONS. THESE CODES HAVE BEEN DESIGNED WITH YOUR SAFETY IN MIND. BE SURE YOU COMPLY WITH THEM.
- B** WE RECOMMEND THAT A SEPARATE CIRCUIT BE LEAD FROM THE HOME ELECTRICAL DISTRIBUTION PANEL PROPERLY PROTECTED WITH A FUSE OR A CIRCUIT BREAKER. WE ALSO RECOMMEND THAT A GROUND FAULT CIRCUIT BE USED. CONSULT A LICENSED ELECTRICIAN FOR ALL WIRING.
- C** THE GROUND TERMINAL ON THE THREE PRONG PLUGS SHOULD NEVER BE REMOVED. THEY ARE SUPPLIED AND DESIGNED FOR YOUR PROTECTION.
- D** NEVER MAKE ADJUSTMENTS TO ANY ELECTRICAL APPLIANCE OR PRODUCT WITH THE POWER CONNECTED. DO NOT ONLY UNSCREW THE FUSE OR TRIP THE BREAKER, REMOVE THE POWER PLUG FROM THE RECEPTACLE.

Monthly Mandatory check-up:

1. Inspect the pump for any obvious condition that necessitates cleaning, correction, adjustment or repair.
2. Clear the surrounding of any paper, leaves or other debris.
3. Ensure that the pump is secure for proper operation.
4. Ensure that there is adequate clearance from any combustible materials or structure. Stored materials must be kept away from the pump. Shelves or cabinet structures must not be in close proximity over the pump.
5. Ensure that the motor is securely plugged into a proper GFCI electrical outlet.
6. Test the GFCI outlet by pressing its test switch. This should prove that the outlet is energized and will trip off to protect against a ground fault. Be sure to reset the GFCI by pressing its reset switch.
7. Observe that the plumbing can carry the water safely into the residence.

Material required for drilled well application (indoor use only)

Shallow well pump installation

- Desired length of polyethylene 1" pipe, 100 PSI, CSA or UL approved, to link up from pumping level to pump.
- 1 1" foot valve (750756 or 750752P).
- 1 well seal, as per well casing diameter (750929 6" x 1").
- 1 1" well seal elbow (750860).
- 2 1" male adaptors (750865 or 750871).
- 8 1" stainless steel clamps (750885).
- Teflon tape.

Tank installation

- Desired length of 1" braided hose (750919) to link up from pump to tank. Keep tank as close as possible to the pump.
- 1 tank T (650651).
- 1 drain valve (650659)
- 2 1" female adaptor.
- 1 1" male adaptor (750865 or 750871).
- 3 1" stainless steel clamps (750885).
- Teflon tape.

Tools

Screwdrivers, hacksaw to cut pipe, knife to assist in pipe cutting, round file to smooth pipe ends, pipe wrench, adjustable wrench to tighten fittings, propane torch and welding material.

APPLICATION

- This pump is designed for shallow well installation for water level up to 25 feet.
- CAPACITY:

	USGPH		LPH
5'	850	1.5m	3200
10'	730	3.0m	2760
15'	620	4.5m	2350
20'	540	6.0m	2050
25'	450	7.5m	1700

FRICITION LOSS IN
PIPE NOT INCLUDED

FEATURES

- Easy to prime pump body.
- Totally enclosed, fan cooled motor, bearing to bearing. Built for continuous use.
- Full time connected run capacitor, to eliminate starting wear vs regular motor.
- Thermal and overload protection.
- Noryl impeller, built-in injector
- 1/2 HP, 115 / 230 VAC, 60 Hz, 8A (at start:17A).

INSTALLATION STEPS

STEP 1

We recommend that you install your pump in a clean and dry location where there is adequate room for servicing at a later date. Protection from freezing temperatures and good ventilation should be considered as well, to provide the pump an environment for long life. Locating the pump as close as possible to the water source will reduce friction losses encountered in the suction pipe.

Friction losses in the suction pipe must be taken into consideration when the horizontal offset is greater than 50 feet. The suction pipes should be increased from 1" to 1 1/4". This will reduce friction losses and allow the pump to give maximum performance.

A new well should be checked to determine that it is free from sand. Sand will damage the seal and the impeller. Have your well driller clean the well before your installation.

Never run the pump dry. Damage to the seal may occur. Fill pump body and suction pipe with water before turning on the power.

THE RUN OF HORIZONTAL PIPE FROM THE TOP OF YOUR WELL INTO THE HOUSE, WHERE YOUR PUMP WILL BE LOCATED, MUST BE INSTALLED IN A TRENCH, BELOW THE FROST LEVEL IN YOUR AREA.

SHALLOW WELL APPLICATION

SEE DIAGRAM ON PAGE 7

STEP 2

Cut the desired length of poly pipe to run from the top of the well to the pumping level. Smooth the pipe cuttings with your round file. (Check that no cut-out parts are left inside of the pipe. This may block the pump ejector or impeller). Tape male adaptor threads with teflon tape and thread adaptor into the foot valve. Slide 2 stainless steel clamps over one end of pipe and use torch to soften pipe. Insert the male adaptor and foot valve into this pipe end. Tighten clamps with screwdriver when cool. **For security against leaks, we suggest that you install 2 stainless steel clamps on each adaptor.**

STEP 3

Insert the well seal elbow through the opening of the seal. Slide 2 stainless steel clamps over the free end of the previously cut pipe and soften pipe with your torch. Attach pipe to the well seal elbow (end protruding at bottom of well seal). Tighten clamps with screwdriver when cool.

STEP 4

Install the well seal and piping assembly into your well casing. Tighten down the well seal bolts using your adjustable wrench.

To facilitate servicing at a later date, you may use a pitless adaptor and a sealed well cap instead of an elbow and a well seal as described in steps 3 and 4.

STEP 5

Install your pump in the house, on a sound foundation, as close as possible to the basement wall. Locate the suction inlet in the front of the pump body. Thread an adaptor into inlet using teflon tape. Do not over tighten.

STEP 6

Cut the desired length of pipe from pump location to the well seal and connect both ends using the previous way, with stainless steel clamps and torch. **Do not fill in your trench to the house until you have checked for any leaks in your connections or trouble in your water system.**

STEP 7

for sand
or well
points

Sand or well points are limited to areas where water bearing sand or gravel lies below the surface, and where there are no boulders or rocks to interfere with the driving into the ground of the point.

The amount of water any "one" well point will supply is usually rather limited. Sometimes, it is necessary to use more than one point to increase the supply of water, entering to the pump's suction.

IMPORTANT : IF USING WELL POINTS A CHECK VALVE MUST BE USED IN THE SUCTION PIPE LEADING TO THE SUCTION INLET, AS CLOSE TO THE PUMP AS POSSIBLE, TO KEEP THE SUCTION LINE AND PUMP WELL PRIMED.

CONTINUE ON PAGE 5 & 6 FOR TANKS AND ELECTRICAL INSTALLATION STEPS

TANK INSTALLATION

SEE DIAGRAM ON PAGE 8

STEP 8 for captive air tanks

Packaged systems have the pump mounted directly to the tank. The pump to tank plumbing fittings are pre-assembled at the factory. You only need to connect the discharge line of your system to your home's plumbing distribution line. When using a separate tank from your pump, we recommend that you install a captive air tank as shown in our typical installation diagram, that has been pre-charged with air pressure at the factory. This air, which is in addition to atmospheric pressure, increases the ability of the tank to deliver more water between on/off cycles, thus increasing the efficiency of your water system. Connect the pump discharge to the tank T, using adaptors and braided hose, then, connect the other side of tank T to your home's plumbing distribution line.

Make sure that the precharged air pressure (before connecting the tank) is 2 PSI less than the starting pressure as per the setting on the pressure switch of your pump.

If you adjust the air pressure after the installation, follow these steps:

- Check the starting pressure of the pump on the pressure gauge;
- Disconnect the power to the pump;
- Open nearest faucet to the tank and relieve all pressure in tank, then close the faucet;
- Adjust the air pressure of the tank (by pumping or removing air at the snifter valve) 2 PSI below pressure switch "ON" setting;
- Turn power back on to pump.

Your tank is now properly precharged. Run the pump through a few cycles to verify that it works properly.

STEP 8 for epoxy or glass lined tanks

Other types of tanks may be used, including galvanized standard tanks, epoxy or glass lined tanks. These products do not achieve the benefits of the captive air tanks.

Epoxy or glass lined tanks with a float have to be precharged by the installer. Assuming the tank is plumbed to pump and all connections are checked for leaks, follow these steps:

- Run pump through one complete cycle, until pump shuts off;
- Disconnect the power to the pump;
- Open nearest faucet to the tank and relieve all pressure in the tank, then close the faucet;
- Close service line gate valve;
- With a car tire pump, inject air into the snifter valve located in the tank. Watch the pump pressure gauge and stop pumping air when the pressure reaches 2 PSI below the pressure switch "ON" setting;
- Reconnect the power to the pump;
- Run the pump through one complete cycle;
- Open service line gate valve.

Your tank is now properly precharged. Run the pump through a few cycles to verify that it works properly.

Not recommended for galvanized tanks

Galvanized standard tanks require an air volume control to be used with a jet pump. We do not recommend the installation of this type of tank with your jet pump. This type of galvanized tank is recommended for use with piston pumps.

ELECTRICAL INSTALLATION

STEP 9

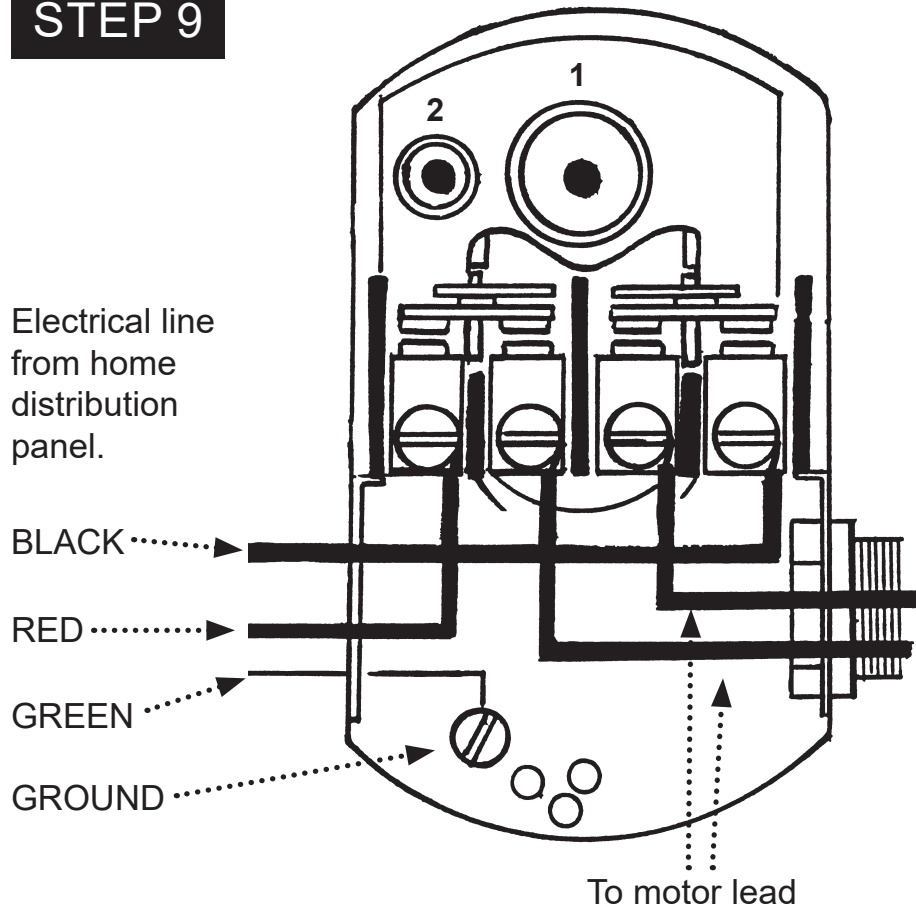

Electrical line
from home
distribution
panel.

BLACK

RED

GREEN

GROUND

To motor lead

VOLTAGE SELECTION SWITCH

1. POWER off.
2. Please SELECT the up knob position for 115 V or down knob position for 230 V.

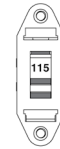

3. CONNECT to appropriate power source.

We recommend that a licensed electrician be employed to do the proper wiring to the pressure switch, and to permanently ground the motor in accordance with the electrical codes in your area.

Do not use an extension cord to connect your pump to the power source. From your distribution panel to the pressure switch, we recommend a wire gauge not smaller than 14 gauge.

This is a dual voltage 115/230 pump. The voltage selector switch is located inside the terminal box on the motor. The motor is factory wired at 115V. For 230V selection, please open the terminal cover and set the switch to the proper voltage. (See above drawing on right).

The pressure switch setting (start/stop 20/40 or 30/50) has been made at the factory. Adjustments may be done to give other operating pressures.

Adjustment or modification of start/stop setting of pressure switch has to be done carefully.

Turn the adjustment nut half a turn at a time.

Turn nut 1 clockwise to raise start and stop pressure setting. **Never turn nut 2. This will change the 20 PSI range between start and stop pressure and may damage your tank's bladder or modify the efficiency of your water system.** Check system operation after each adjustment.

SHALLOW WELL APPLICATION

STEP 5 Install your pump and thread an adaptor into inlet.



STEP 6 Cut poly pipe and connect both ends.

STEP 3 Insert well seal elbow through the seal and attach to pipe.

STEP 4 Install well seal and piping into well casing.

STEP 2 Cut poly pipe and install the check valve.

Well point optional installation

STEP 7 You may install one or more sand points to increase the supply of water.

Check valve,
close to pump.

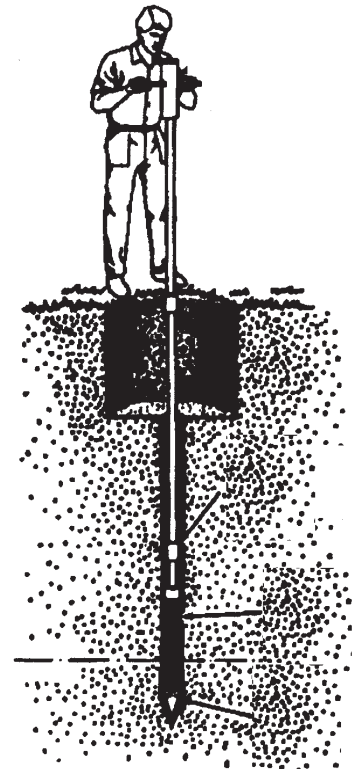
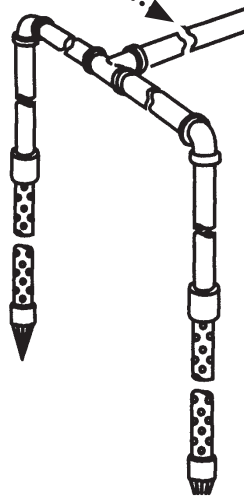

TANK INSTALLATION

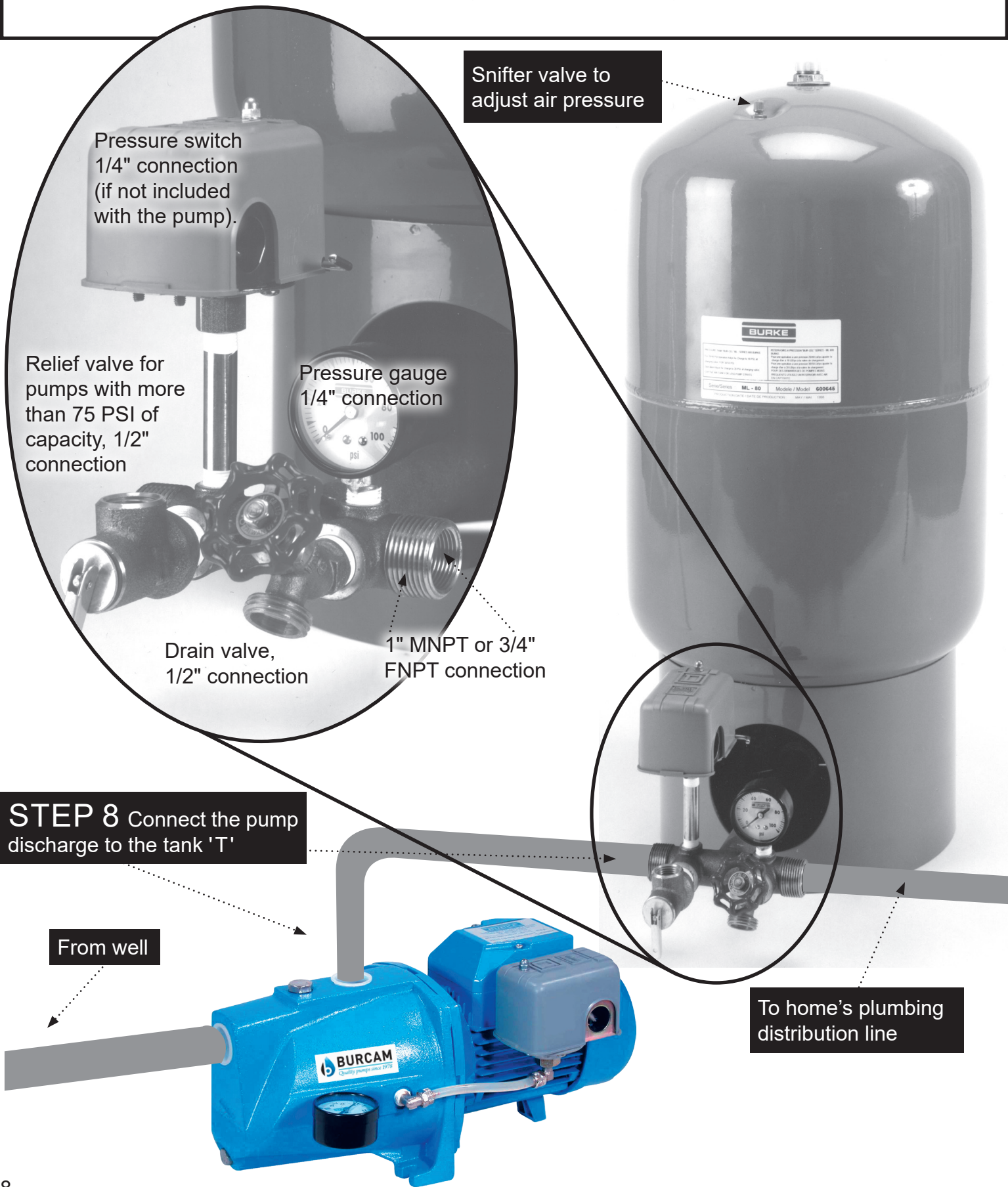

REPAIR PARTS

Ref	Part	Description	Ref	Part	Description
1	506391	C.I. pump body	22	506073W	Motor fan
2	750769	Pressure gauge	23	506072GP	Motor end bell
3	52319	1/4"NPT 1/8"barb brass adaptor	24	506385	Wave spring washer
4	506052	Nozzle "O" ring	25	350335	Motor bearing fan side
5	750748	Plastic tubing	26	506070GP	Rotor/shaft
6	506389	Nozzle	27	506069	Rotor shaft key
7	506380	Venturi	28	350335	Motor bearing pump side
8	506388	Venturi "O" ring	29	750957S	Pressure switch
9	506053	Venturi "O" ring	30	506075	Motor/pump foot
10	506085	Diffuser	31	506300	Priming plug
11	506055	Impeller brass nut	32	506400	Priming plug washers
12	506381	Gasket	33	506315	Washer
13	506083	Noryl impeller	34	506299	Draining plug
14	506057	Mechanical shaft seal	35	506067GP2V	Stator winding
15	350129	Pump body "O" ring	36	506386	Grounding screw
16	506059GP	S.S. seal plate	37	506065	Capacitor junction block
17	506060	Sand slinger	38	506094	115/230V selector
18	506062	Body cap screw	39	506064	Motor capacitor
19	506061GP	Pump bracket	40	506014	Cover box junction
20	506383	Motor flange cap screw	41	506384	Cover box screw
21	506074GP	Fan cover			

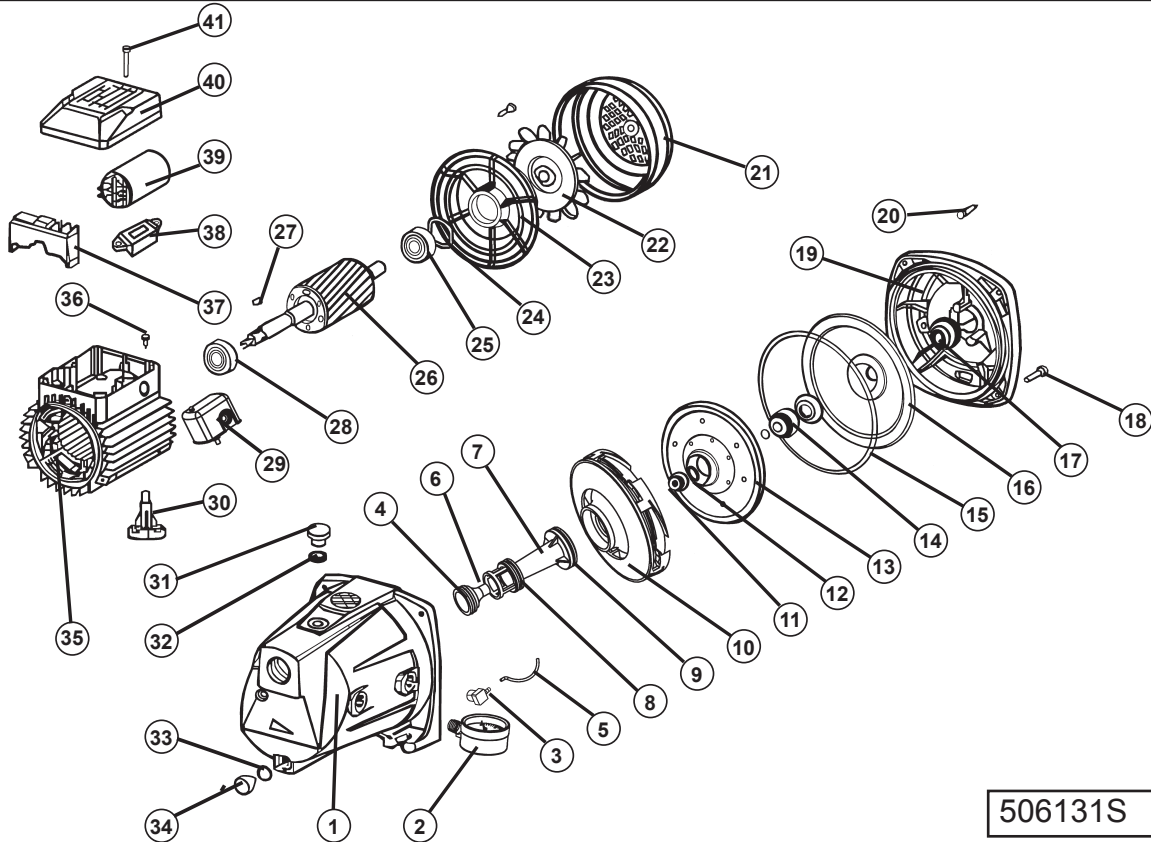

Repair parts may be ordered from your authorized point of sale or from
BUR-CAM PUMPS

TROUBLE SHOOTING GUIDE CHECKLIST

NEVER MAKE ADJUSTMENTS TO ANY ELECTRICAL APPLIANCE OR PRODUCT WITH THE POWER CONNECTED. DON'T JUST UNSCREW THE FUSE OR TRIP THE BREAKER, REMOVE THE POWER FROM THE RECEPTACLE.

TROUBLE	PROBABLE CAUSE	ACTION
Motor does not run.	<ul style="list-style-type: none"> Switch is off position Blown fuse Tripped breaker Dirty pressure switch Defective pressure switch Defective motor 	<ul style="list-style-type: none"> Turn switch to on position Replace Reset Clean Replace Replace
Motor runs but no water is delivered.	<ul style="list-style-type: none"> Pump not primed Leaky suction line Foot valve plugged Ejector nozzle clogged Water level below foot valve Suction lift to great Improper voltage 	<ul style="list-style-type: none"> Prime with clean water Check pipe and pipe connections Clean Clean Check foot valve level Water level lower than lift capacity Check voltage
Pump does not deliver to full capacity.	<ul style="list-style-type: none"> Water level below foot valve Ejector nozzle clogged Excessive friction in pipe Improper voltage 	<ul style="list-style-type: none"> Check foot valve level Clean Too small or dirty pipe Check voltage
Pump does not shut off.	<ul style="list-style-type: none"> Leaky discharge line Motor not up to normal speed Improper setting of pressure switch Ejector nozzle clogged 	<ul style="list-style-type: none"> Check all pipes for leak Check power cable and voltage Reset or replace Clean
Pump starts and stop too often.	<ul style="list-style-type: none"> Pressure tank waterlogged Leaky foot valve Leaky suction line Foot valve do not close properly Pressure switch out of adjustment Leaky discharge line (toilet etc.) 	<ul style="list-style-type: none"> Drain tank and restart Replace Check pipe and pipe connections Clean or replace Adjust on/off setting Check all pipes for leak
Air spurts from faucets.	<ul style="list-style-type: none"> Leaky suction line Air bubbles in water (cavitation) Airlogged tank (galvanized) 	<ul style="list-style-type: none"> Check pipe and pipe connections Check and consult factory Replace air volume control

TO THE END CONSUMER

If you have any problems with the product, before advising the store, where you've purchased the pump, please contact us at 514 337-4415 , and ask for our sales department, and they will be pleased to help you with any questions you might have, concerning your installation.